

#12-66-459

X 1. 10

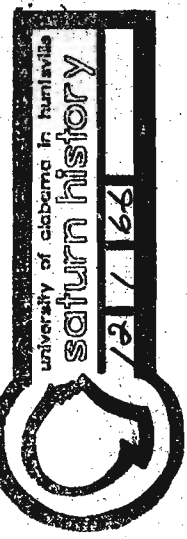

ABSTRACT

Welding Cryogenic Materials for Aerospace Applications

Cryogenic propellant rocket engine hardware and the related test facilities will be described. Methods used for selection of alloys for liquid oxygen and liquid hydrogen service will be discussed. Unique equipment and welding procedures are reviewed with emphasis on welding problems and their solutions to assure reliable hardware and facilities. Examples of specific welding procedures and methods of quality assurance will be given for joining application ranging in size from .001" to 11" thick sections.

SATURN HISTORY DOCUMENT
 University of Alabama Research Institute
 History of Science & Technology Group

Date ----- Doc. No. -----

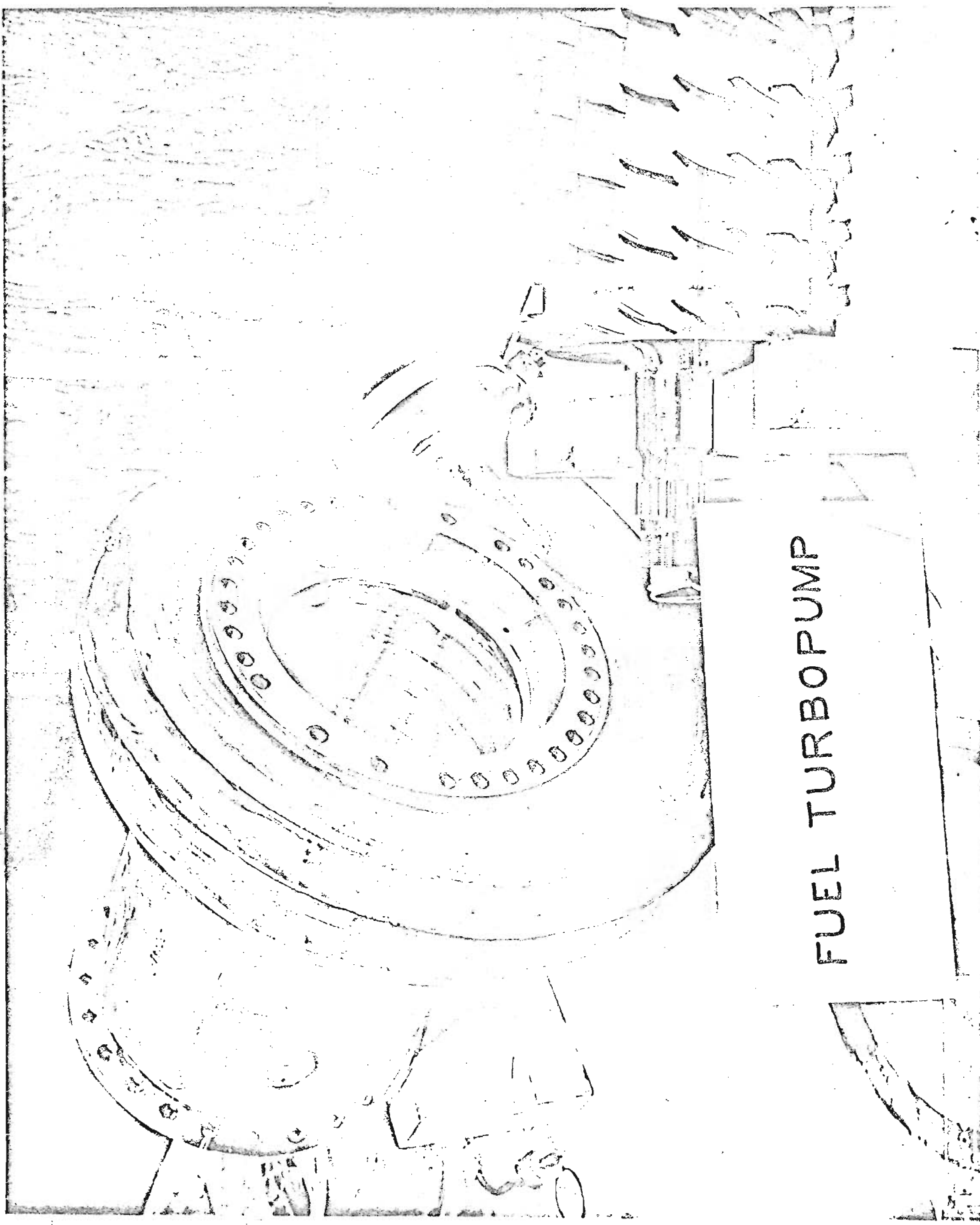

FUEL TURBOPUMP

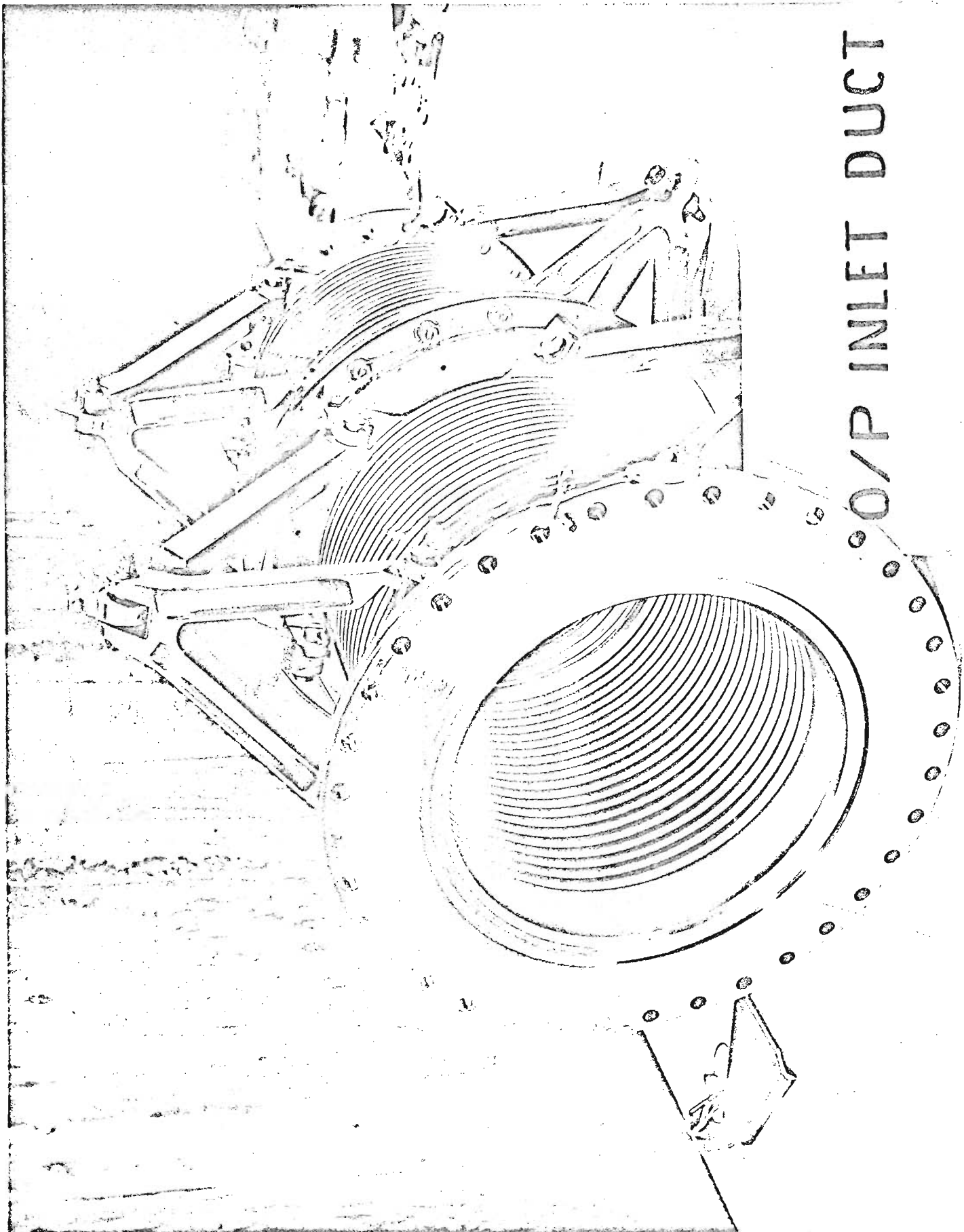

O/P INLET DUCT

X-2

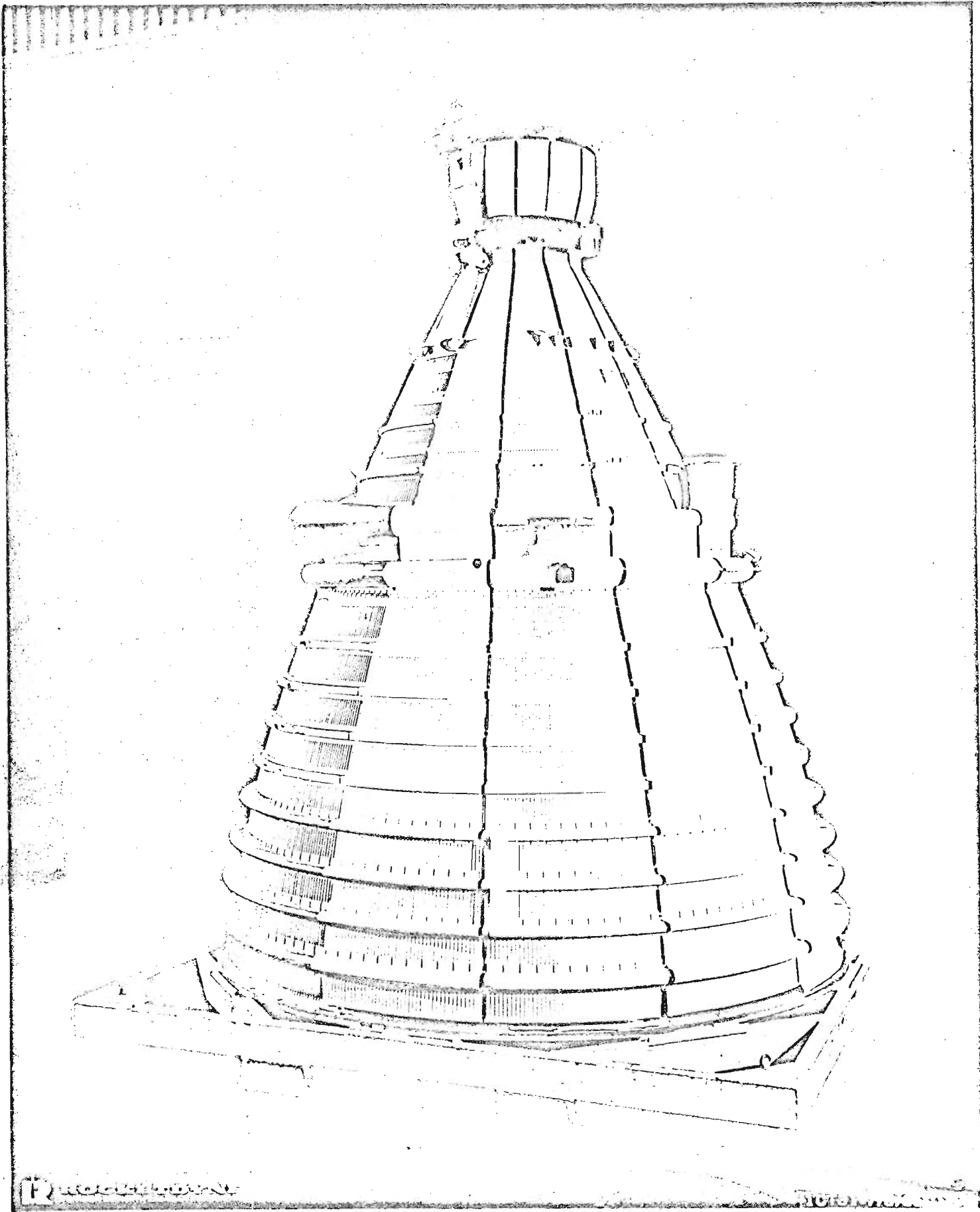

X-3

INTEGRAL TANK ASSEMBLY

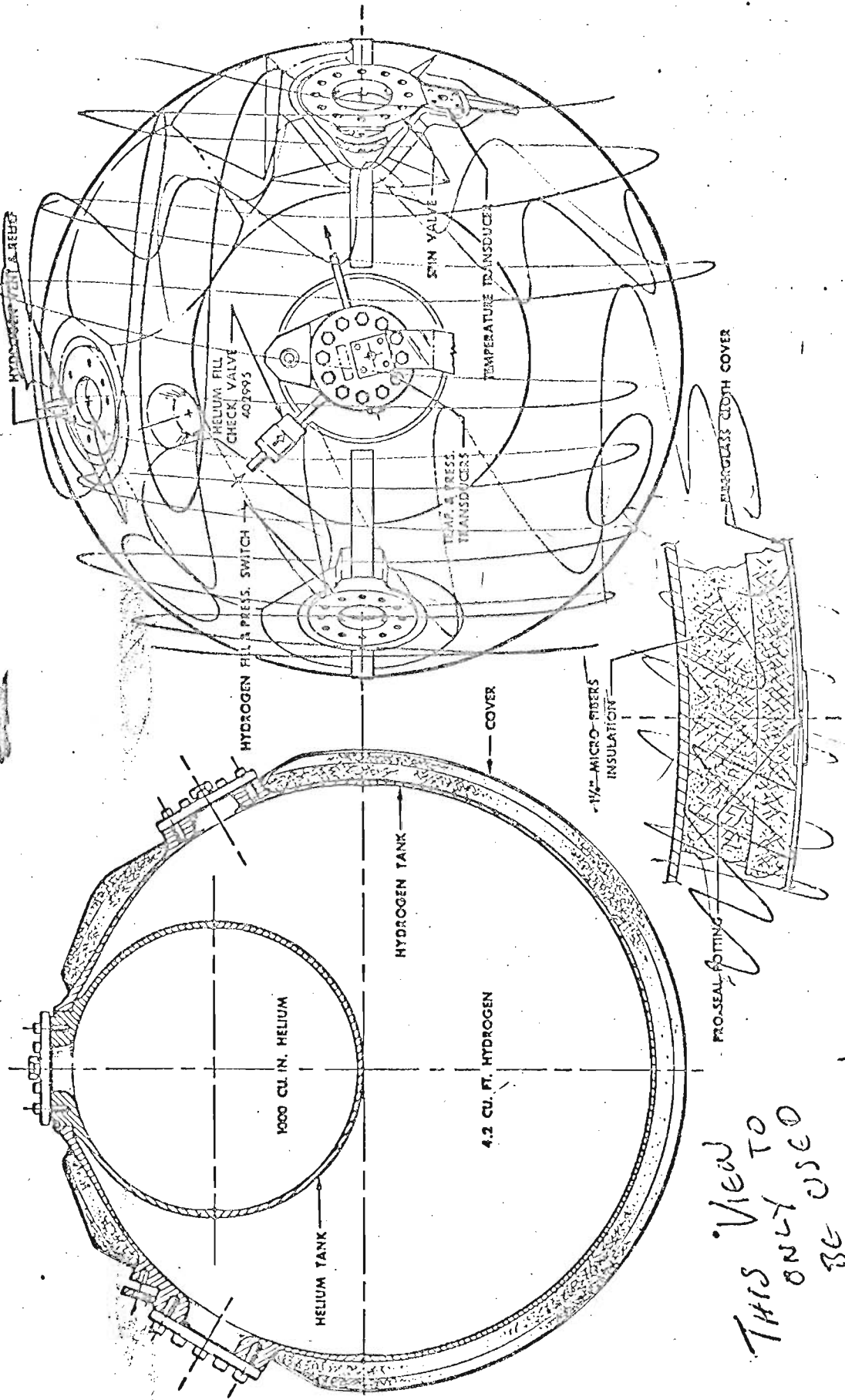

THIS VIEW TO ONLY USED BE

↑ weather only view only

27 X-A

140 T-320
1460 P-51 H2
160 X-51 J-5T
150 Y-140

X-14

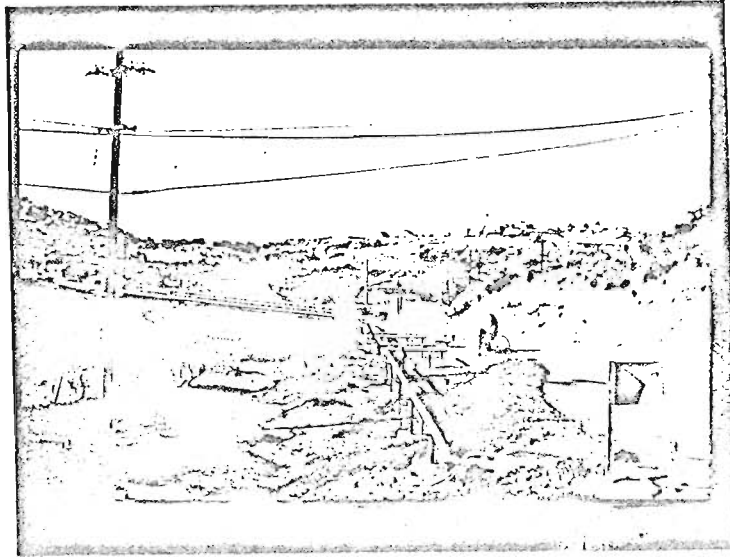

X - 5

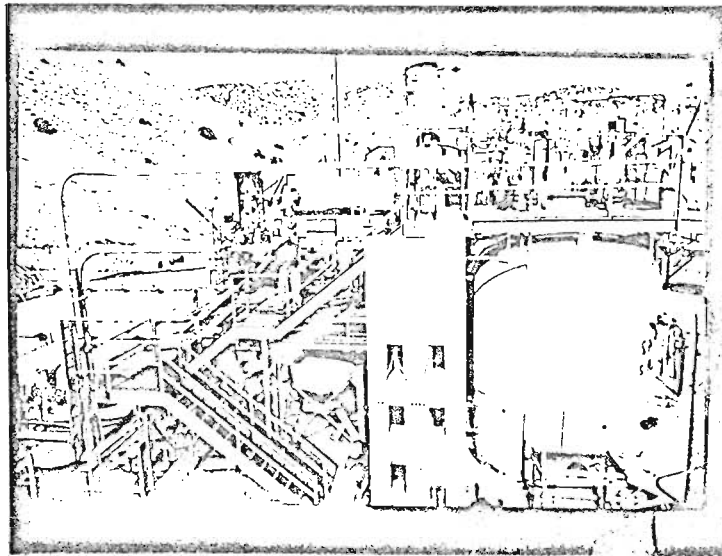

X - 6



X-7

PROOF

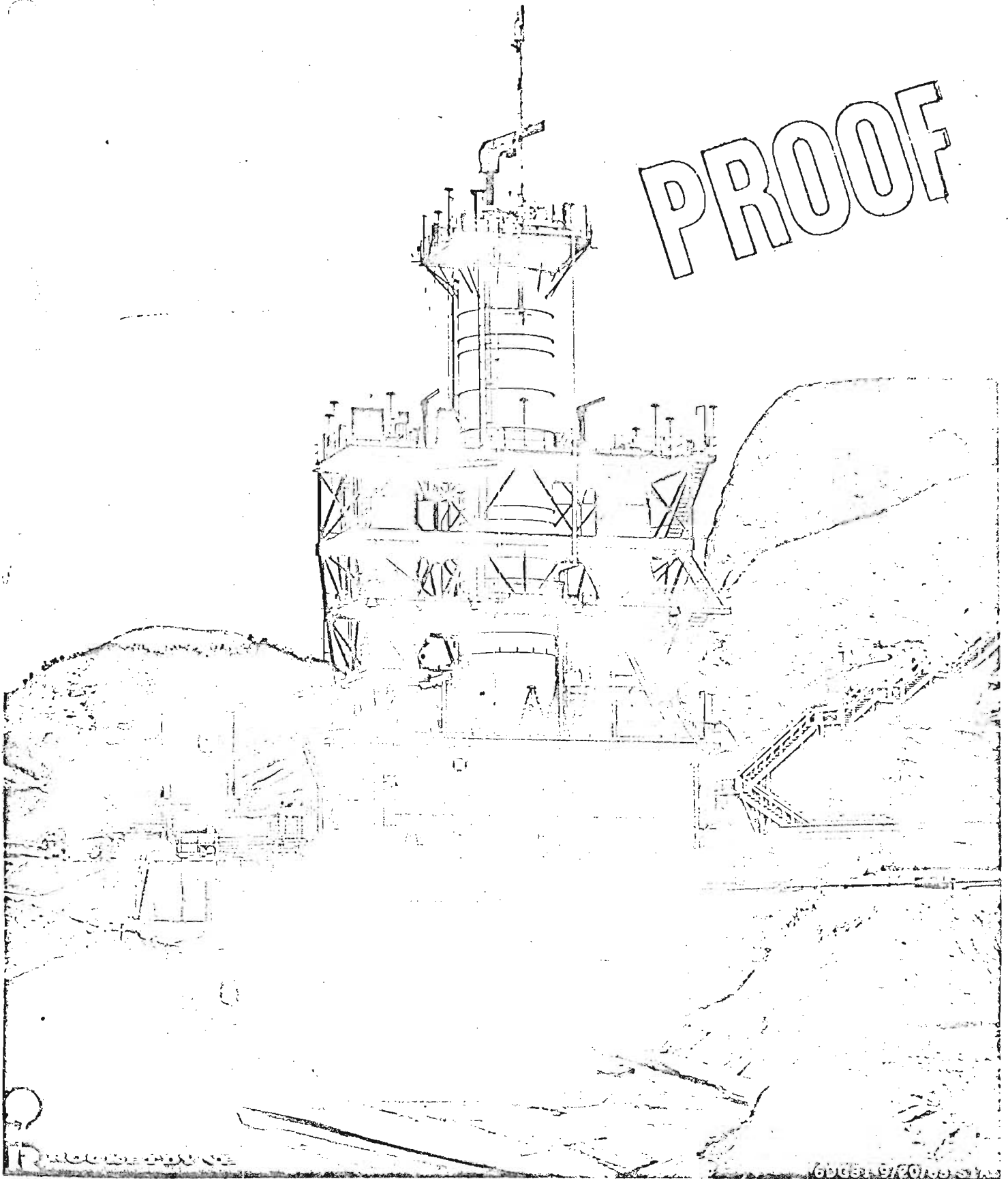

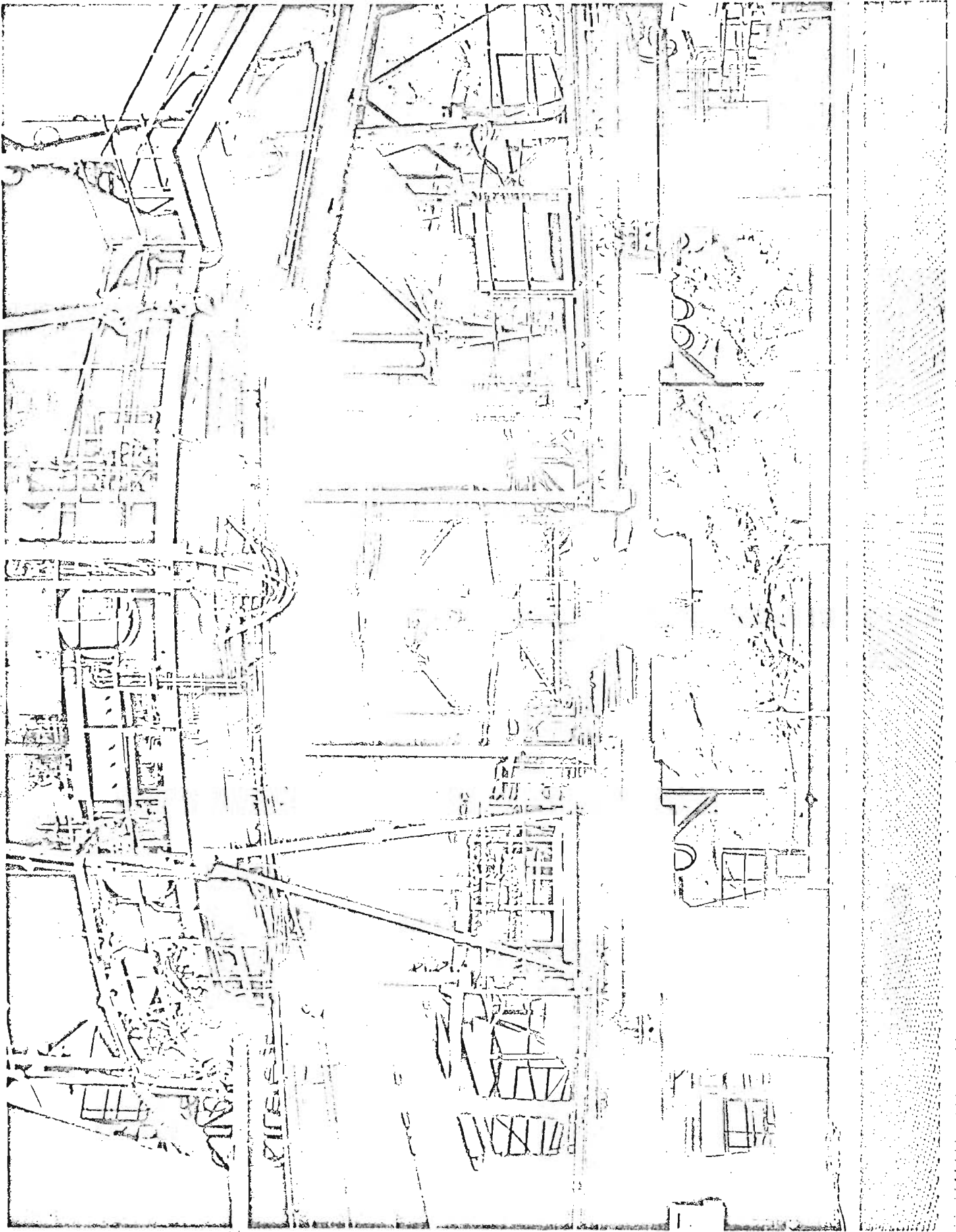

x-9

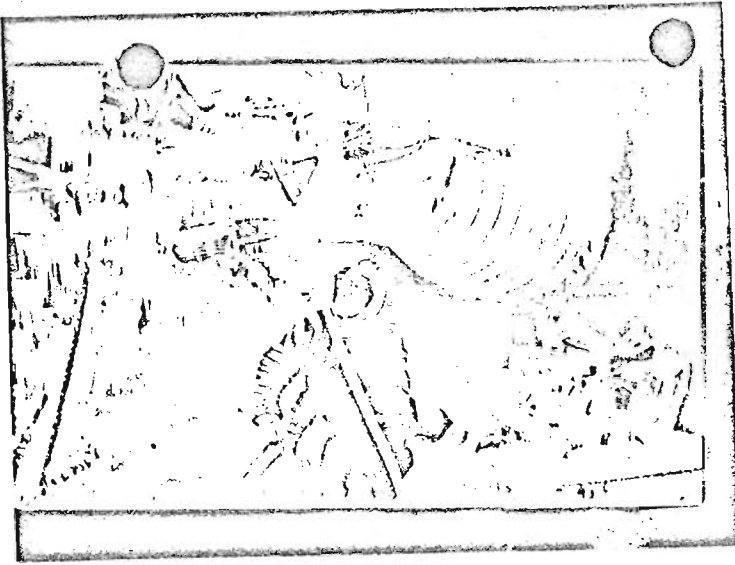

E-22

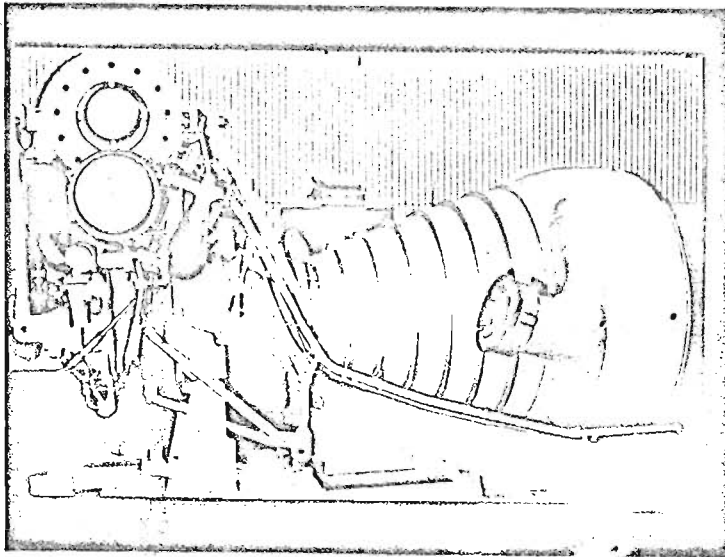

E-1

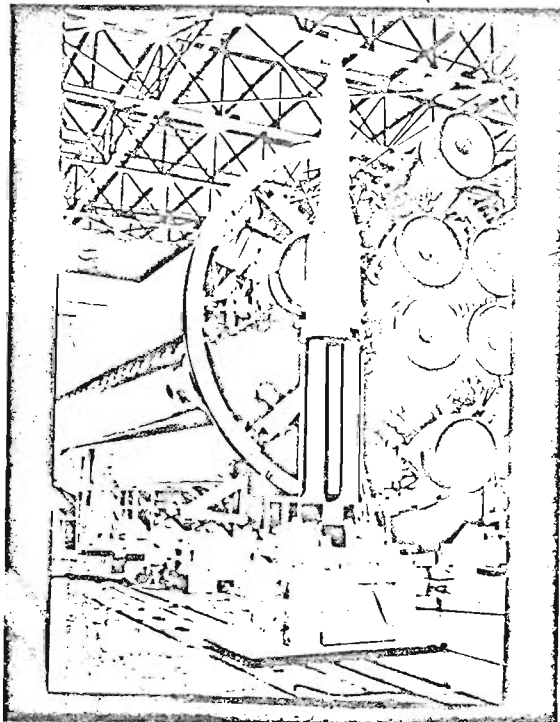

D-34

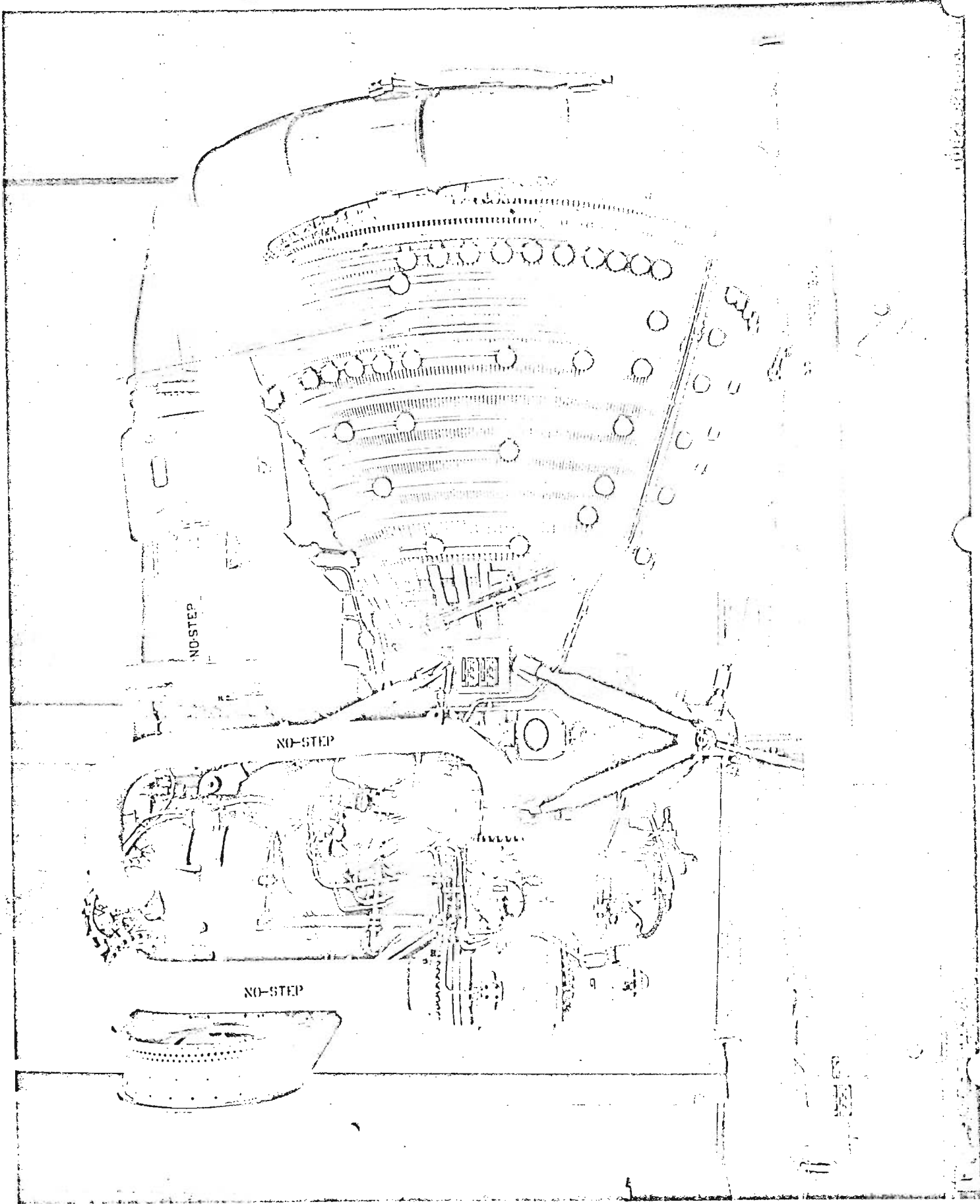



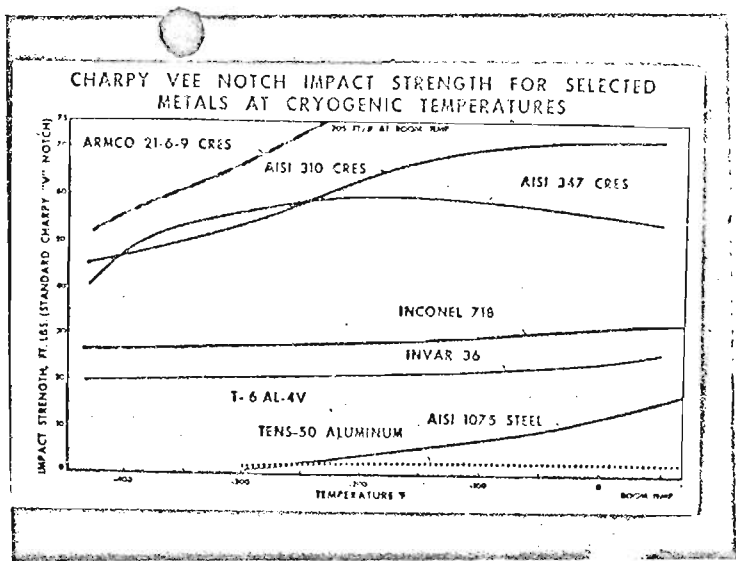
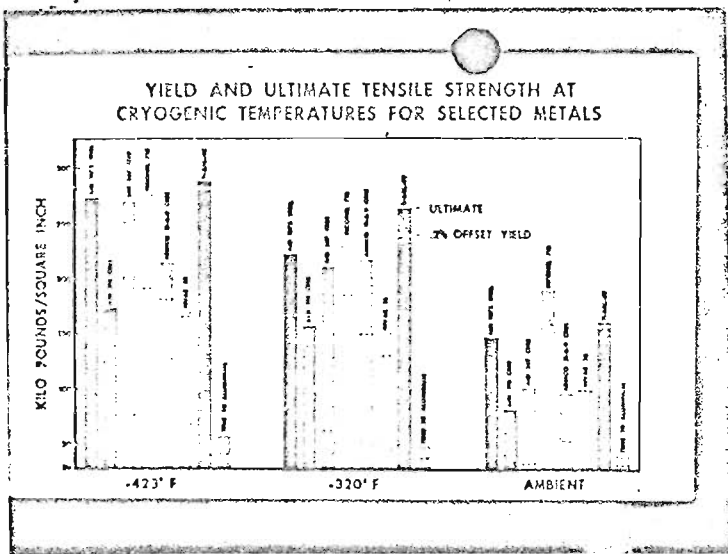

X-10

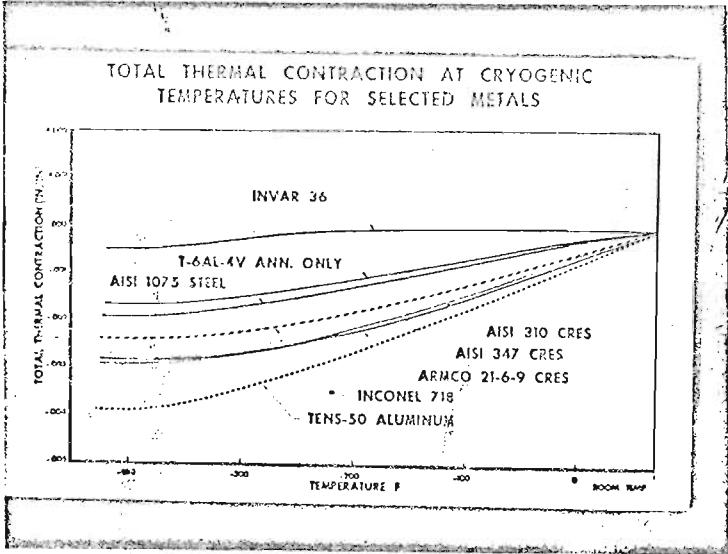

X-11

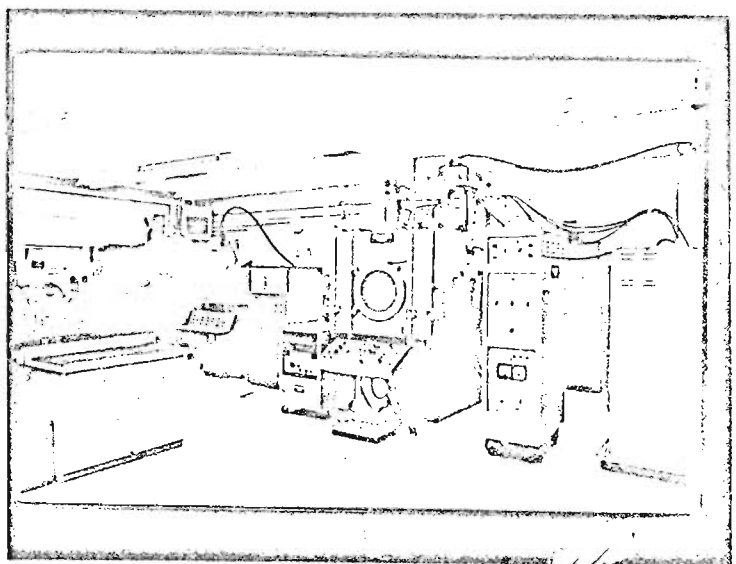

X-12

D-20

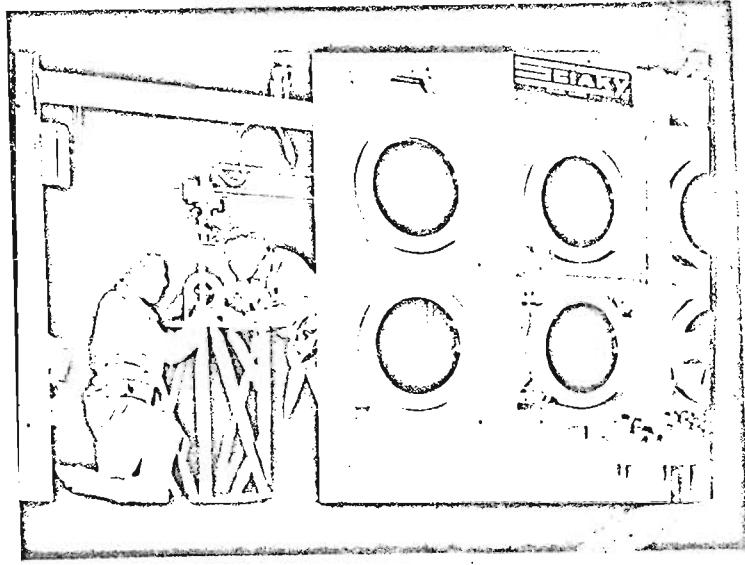
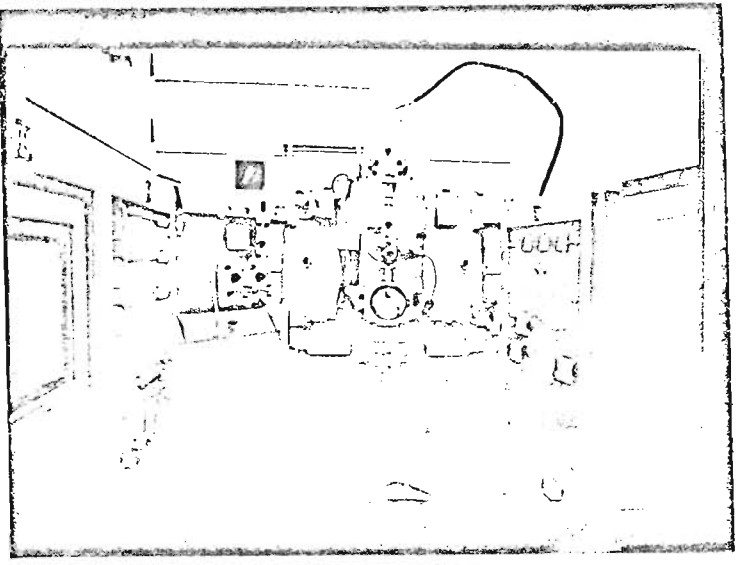

D-30

E-4

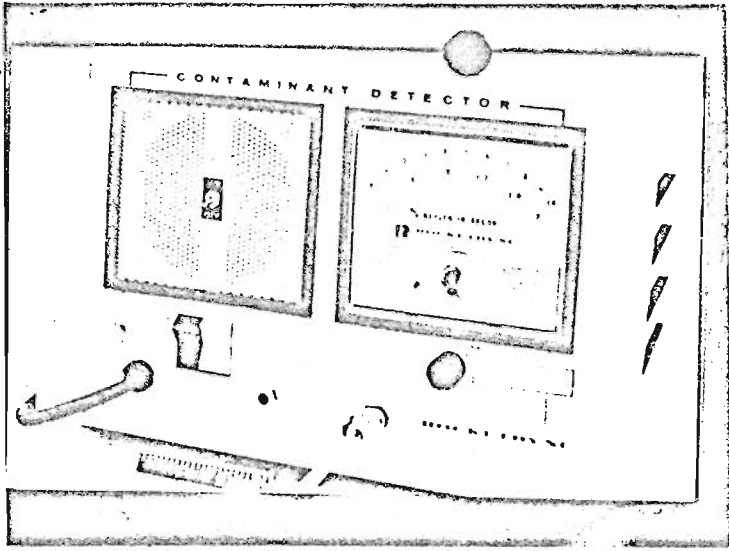

E-13

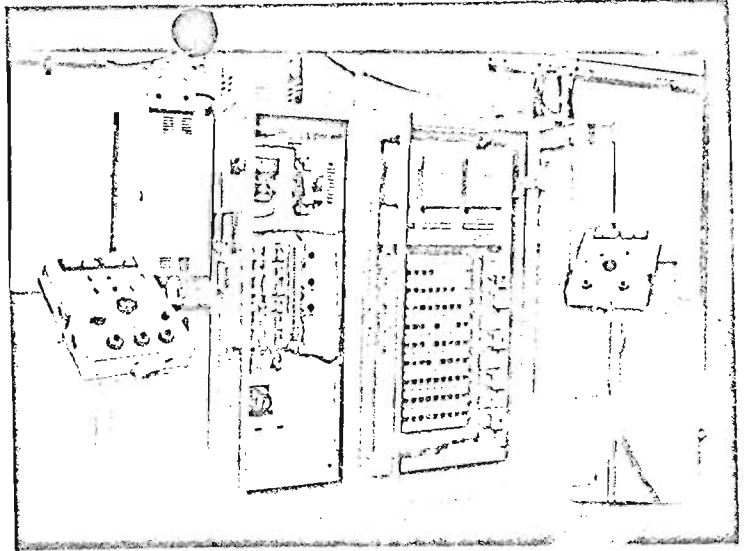

E-20

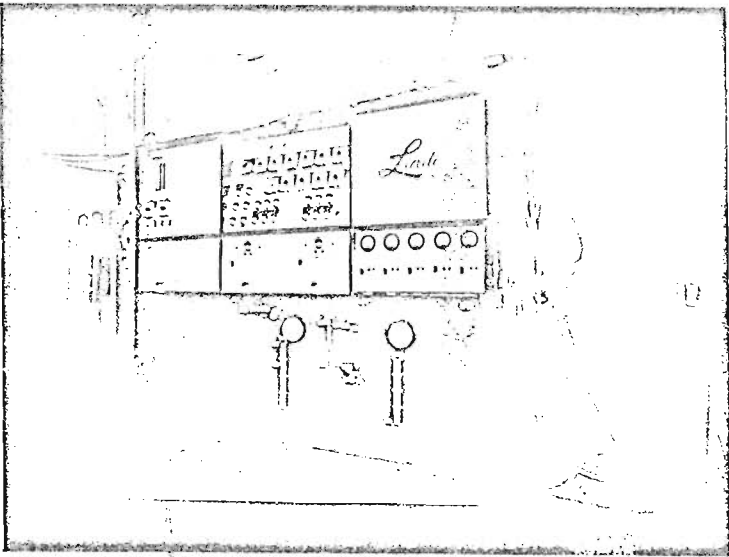

E-27

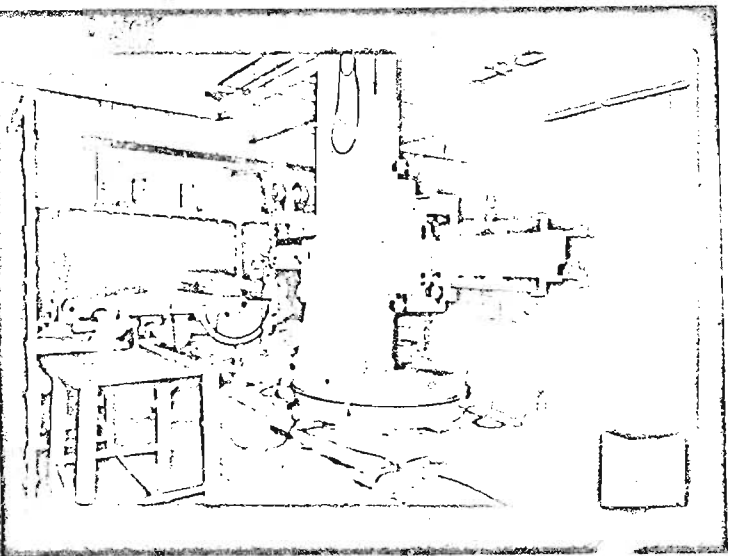

E-29

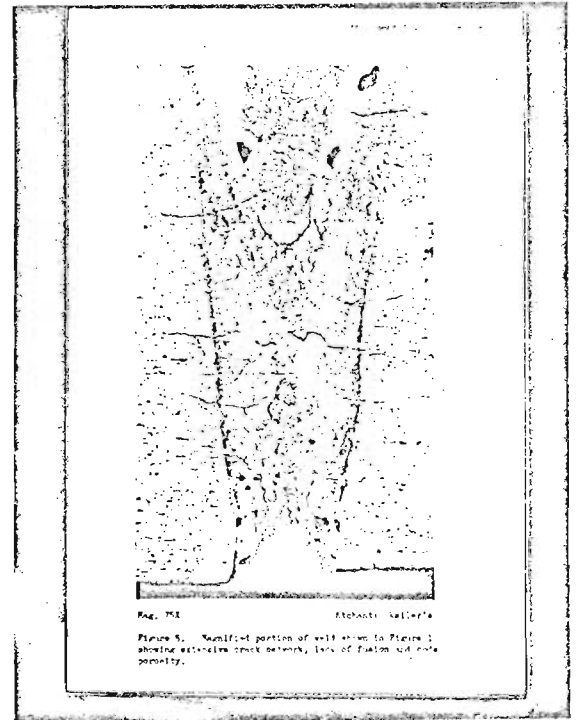

D-18

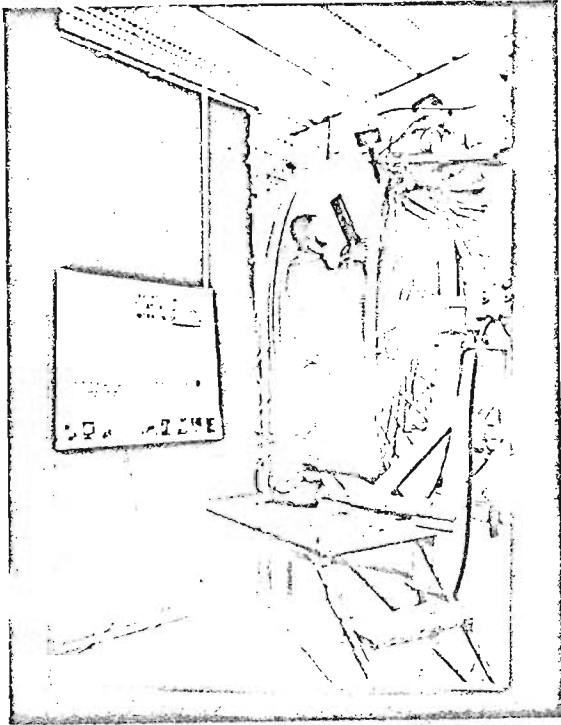

E-14

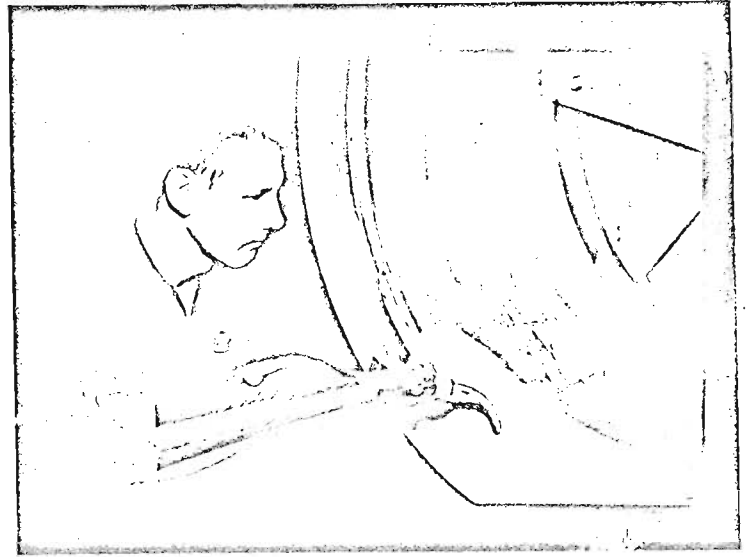

C-20

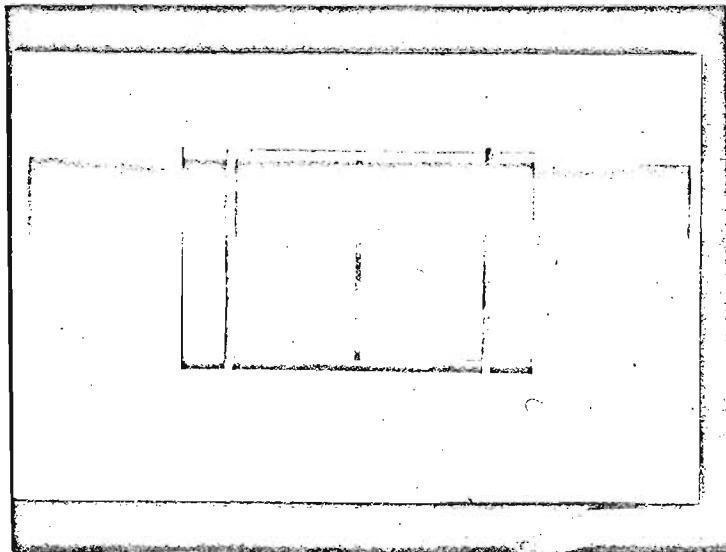

B-61

Handwritten text at the top of the page, possibly a title or reference number, which is mostly illegible due to fading.

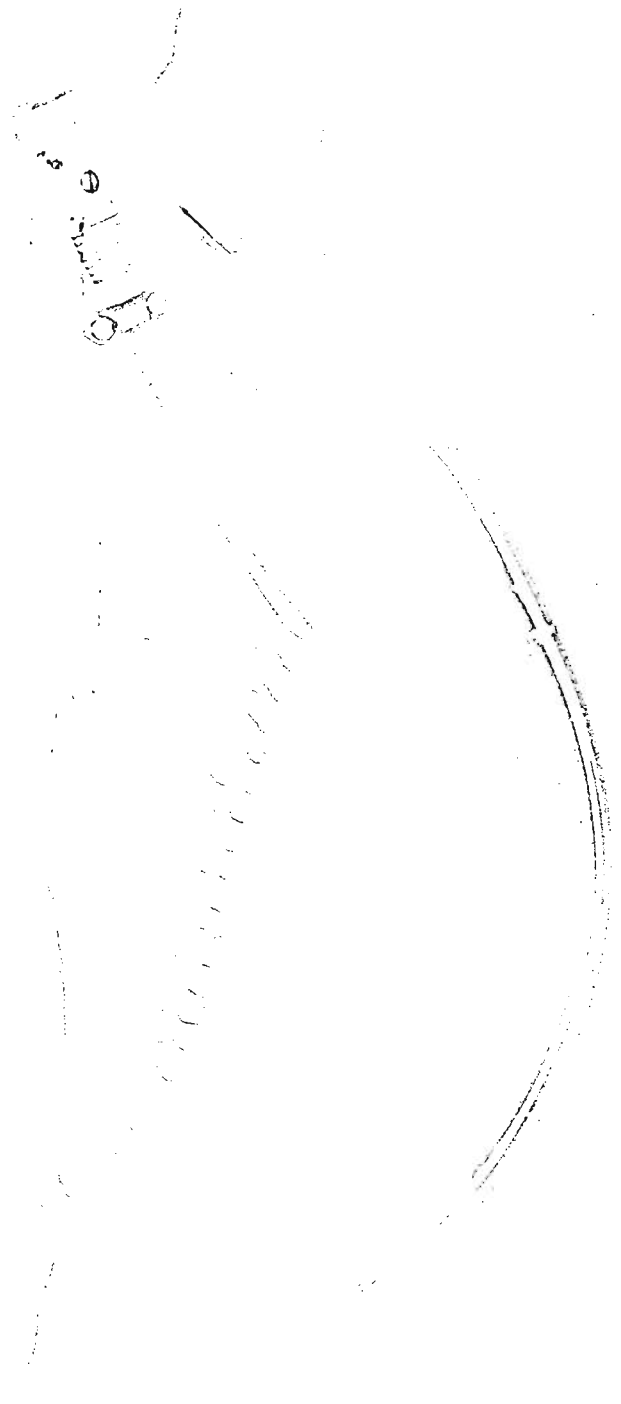
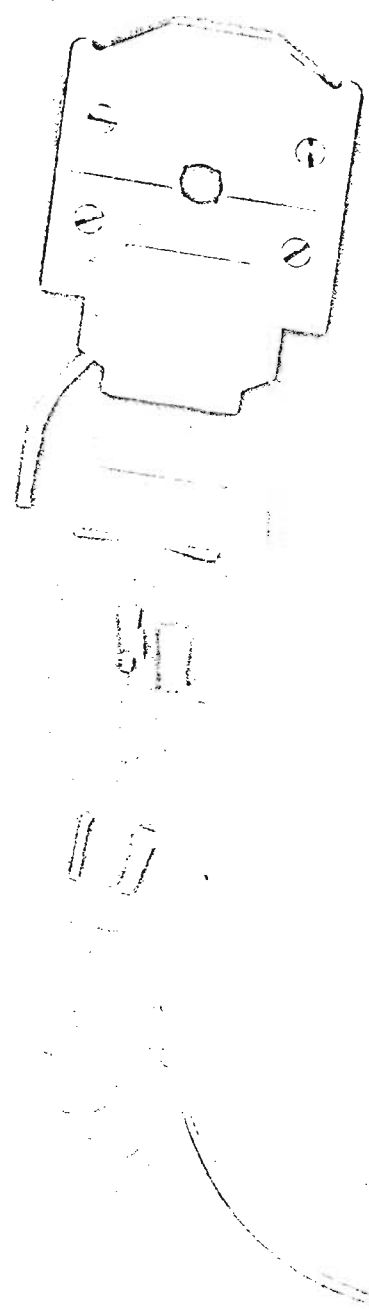

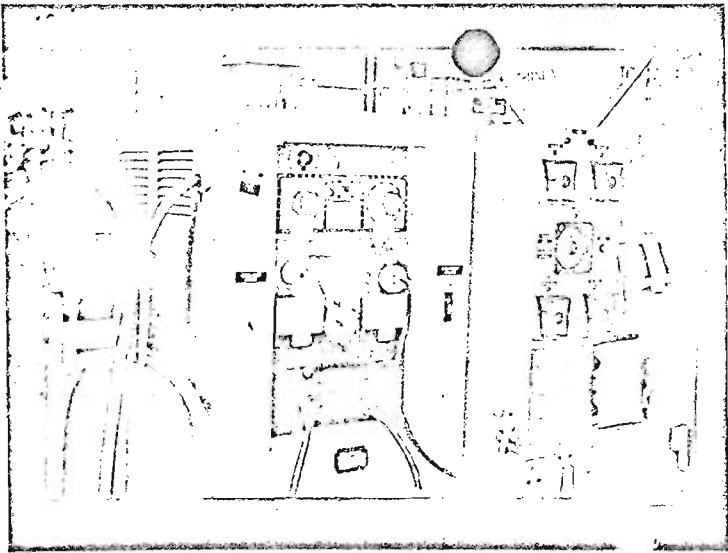

B-6A

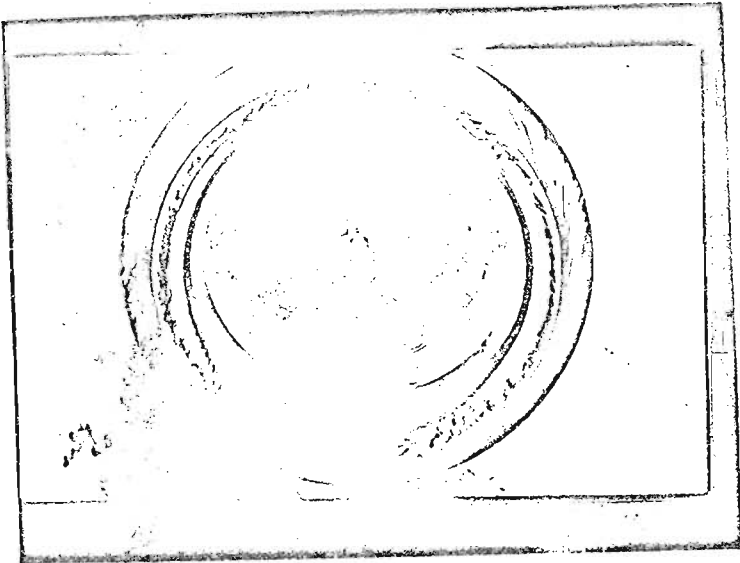
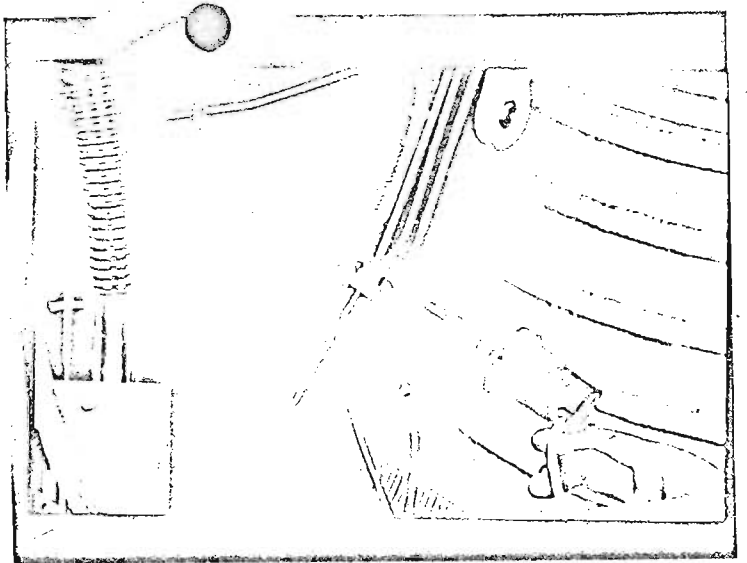

C-31

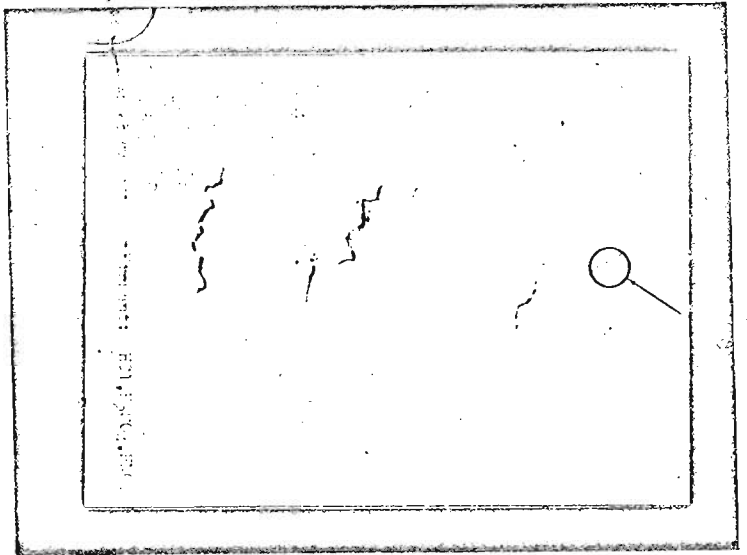

C-32



C-33

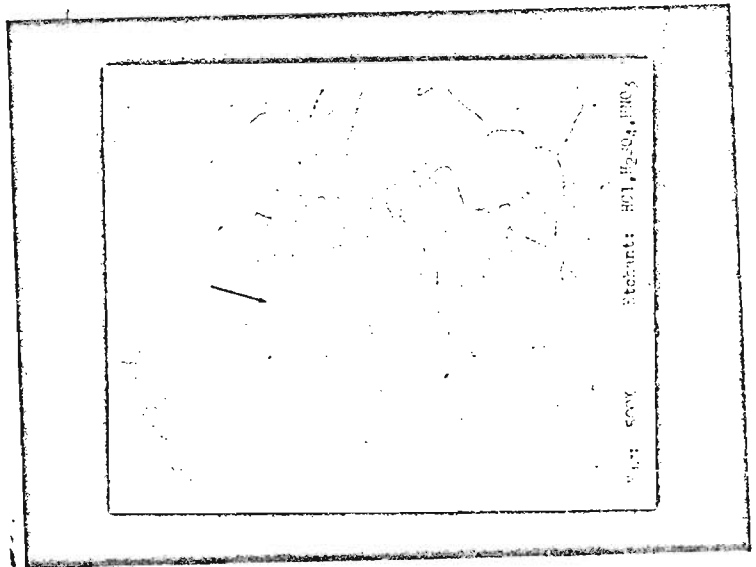

C-34

FILLERLESS FUSION WELD TEST SPECIMEN AND REQUIREMENTS

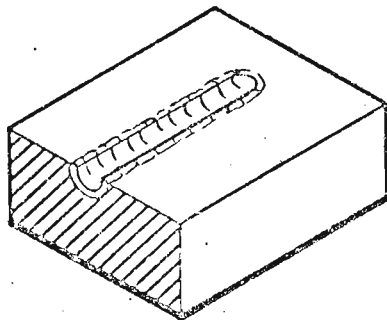
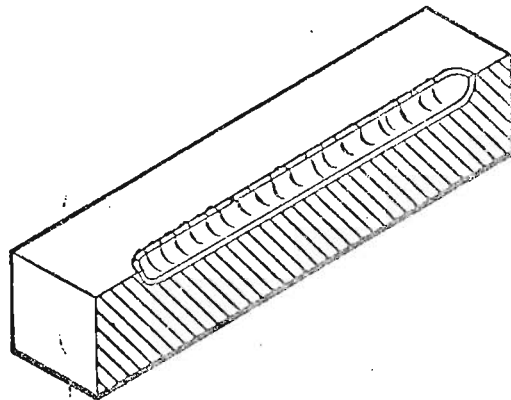
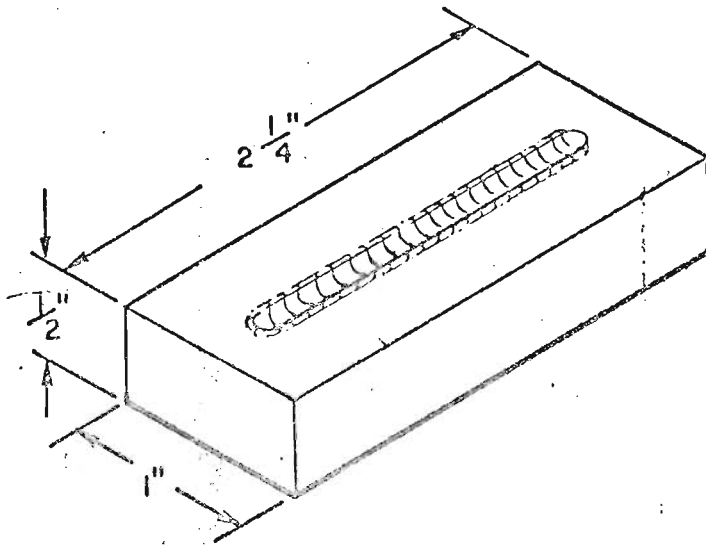

TEST REQUIREMENTS
ALLOWABLE AMPERAGE - 135
ALLOWABLE HEAT INPUT,
JOULES/INCH - 30,000

X-13.

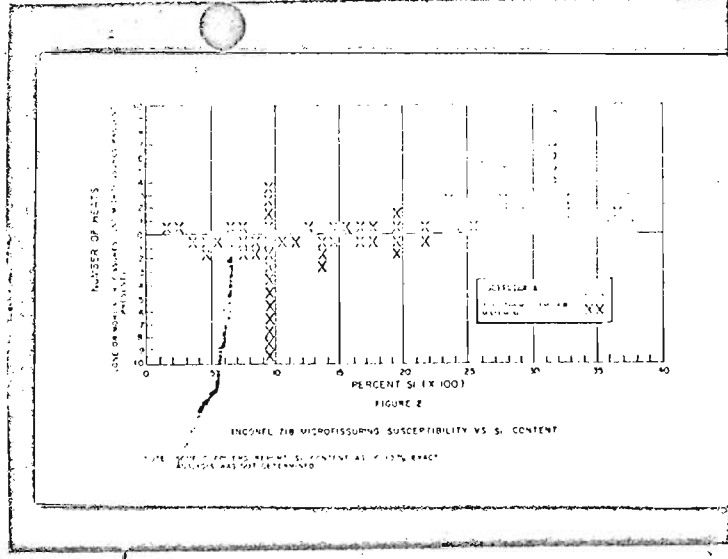
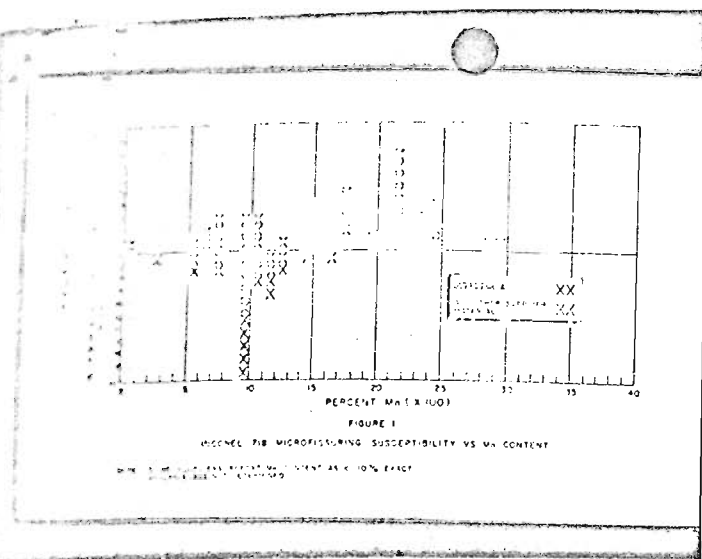

X-14

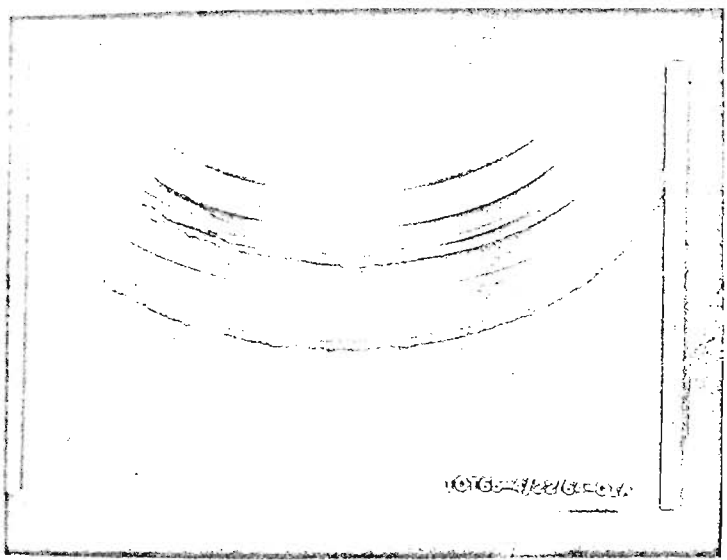

D-15

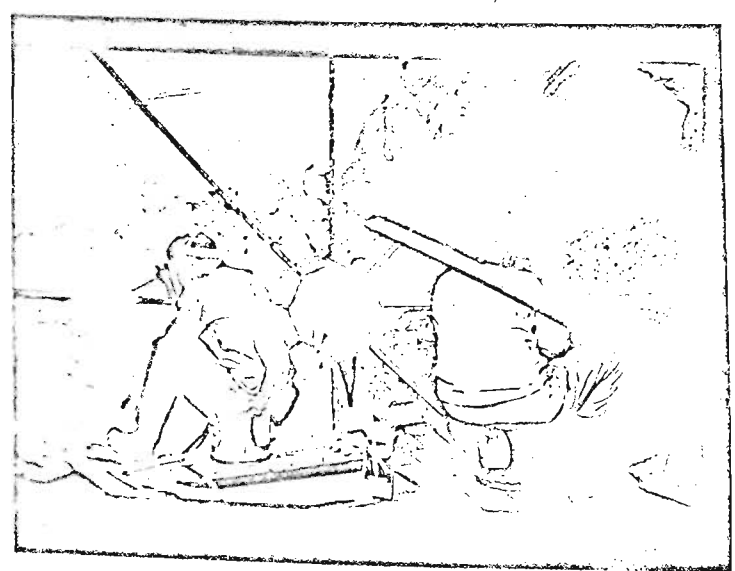

X-16

X-15

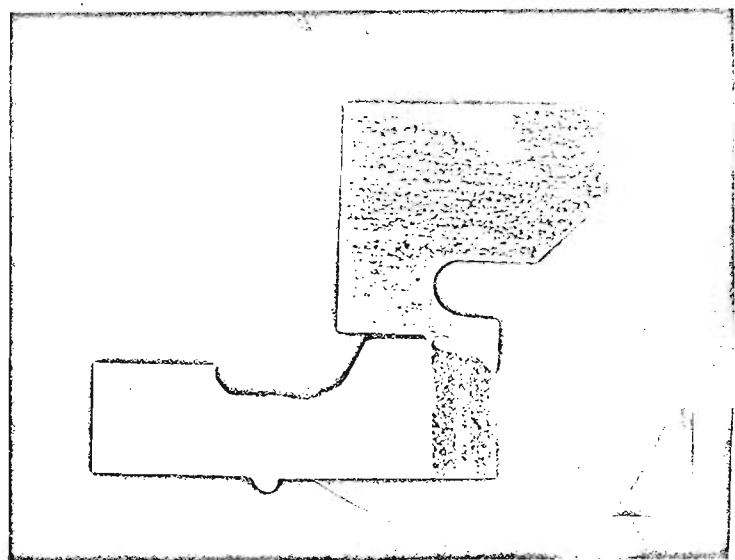

D-16

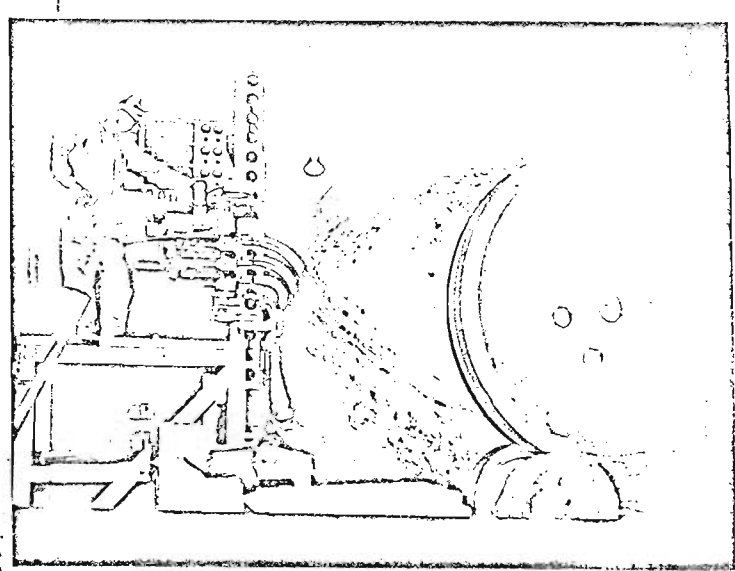

X-17