

1980 Terne-metal roof by
Jones & Herrin, Arch. (HJ&RA)



N ←

West front



c. 1820's (+ Gr. Rev. Portico by Hiram Higgins
Beatty - Mason 1826 (H.A.B.S.) Arch)
Athens, AL

Aug 1961 photos HP Jones

1979 photos R. Allen (+HJ) - JHARR

1 of 13



Beatty -
Mason 1826



1979 photos
R. Allen
→

↙ ↘



WEST
FRONT
RETIRO

↙ ↘

1961 photos
W Jones
→

Knockers of ft.
are modern
c. 1960s
Lockset also



3913



← N
W. Portico



1979 photos - B. Allen
N.E. Serv. Wing → N



→ N
Max Hill



→ N
N.E. Serv. Wing



42

Gazebo in
rear N.E. yard

1930's
H.A.B.S.
photos &
plans show
that this
gazebo was
in front
N.W. yard



22

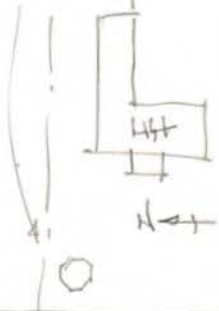

52

+

5/1/13



W

1979 photo
Ralph Allen
J&H
Doh



N

gable
siding of
sash is
20th c.



1980 photo
H Jones
half-dovetail
notch
(most typical
type)

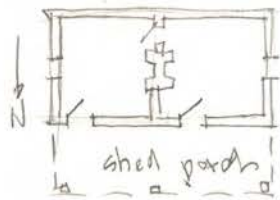
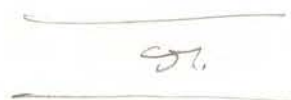

E



Kit. cooking - crane (wrought iron)
probably original. See 1930's
H.A.B.S. measured drawings following
However: crane arm has been cut & welded to
shorten it, & this f.p. is 1960's

This crane reproduced 1981 in "Boardman Kit" at AL Constitution Village



Crane bracket



Crane foot



POTHOOKS



Adjustable-length pothook
(Flat view)

Ketch. F.P.

Desty-Marr Lhs, Athens
Aug 1991 photos 140



Adjustable - length protractor
(on crane arms)

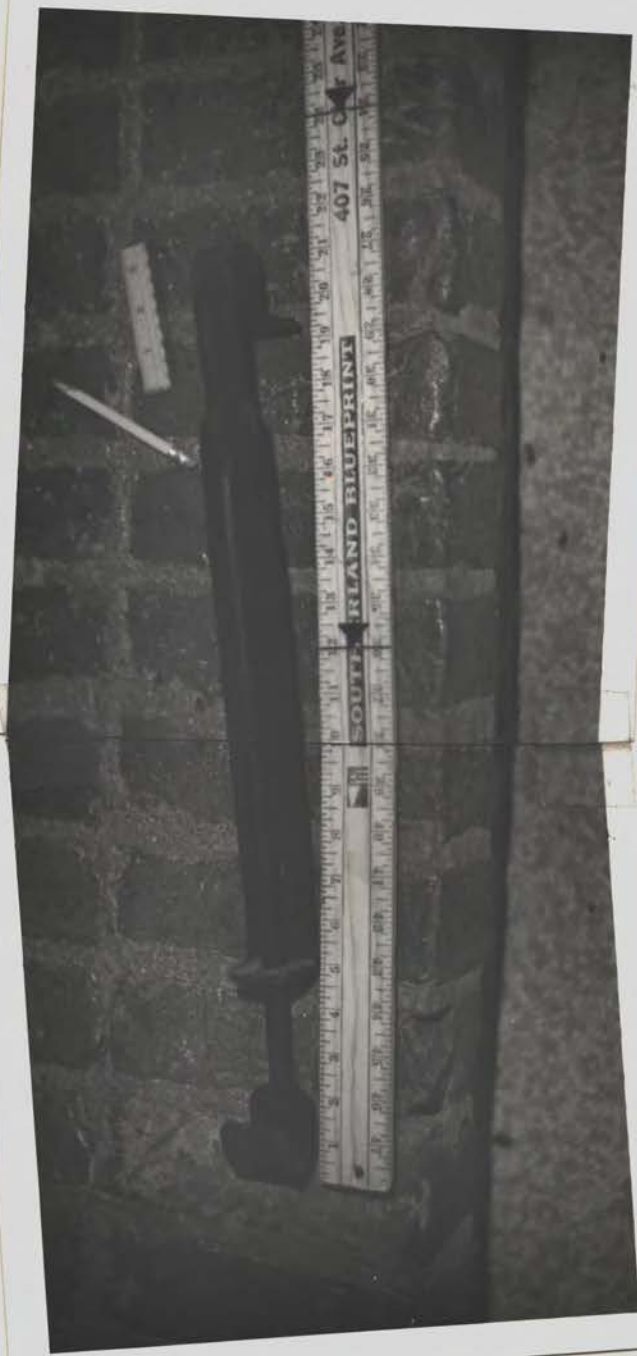

Adjustable
length
protractor -
3/4 view

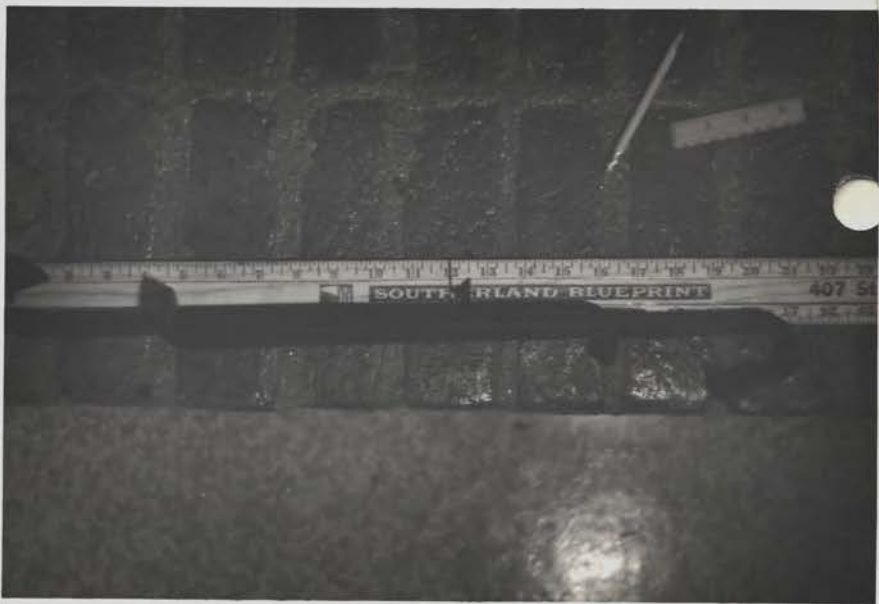

Adjustable - length protractor
(edge view)

ca. 1820 Beatty - Masons Hoe
 Ket Crane - Athens, GA
 20 Aug 81 HJ

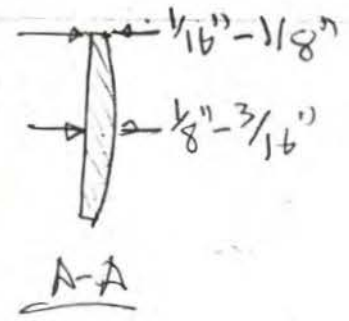
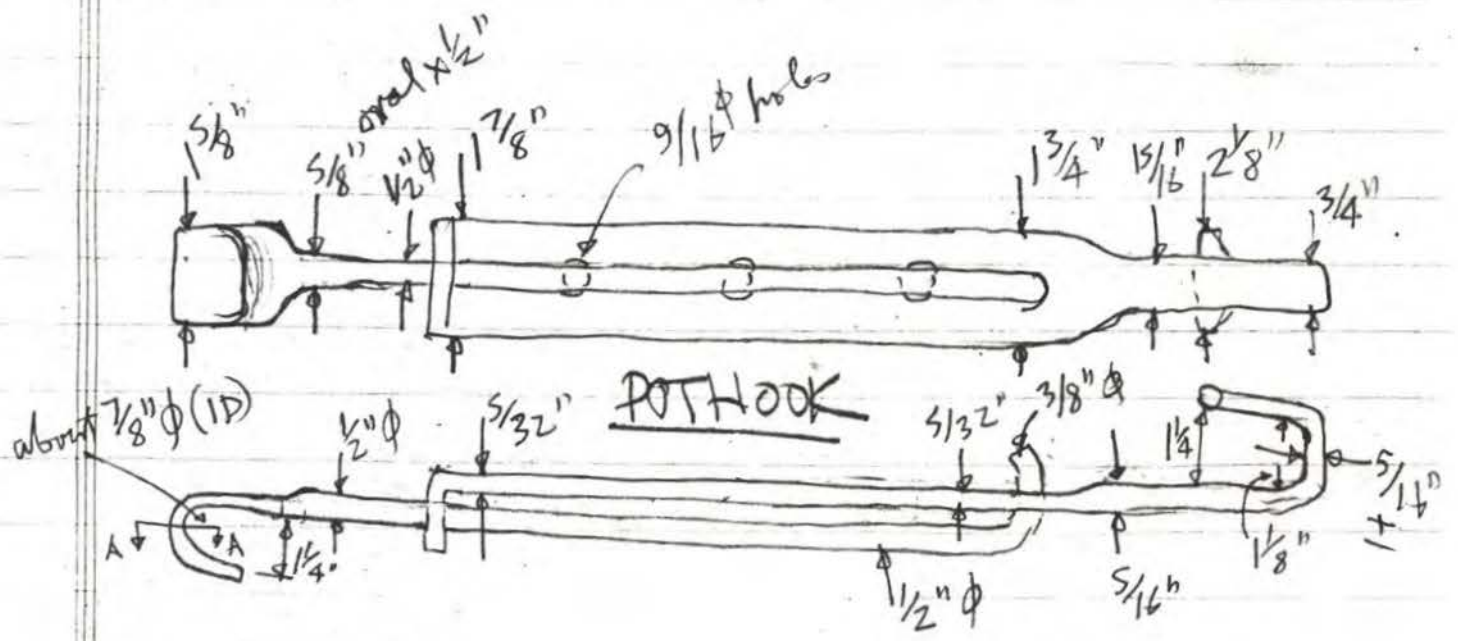
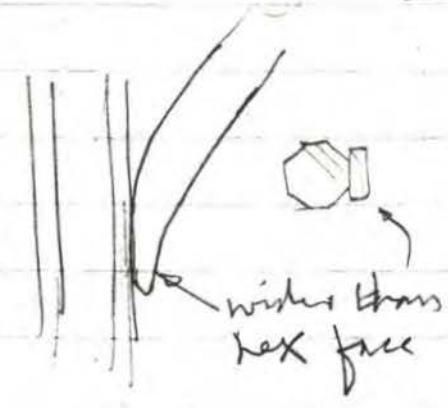
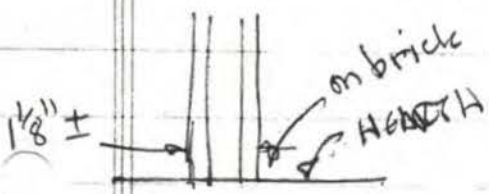
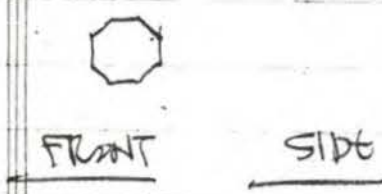
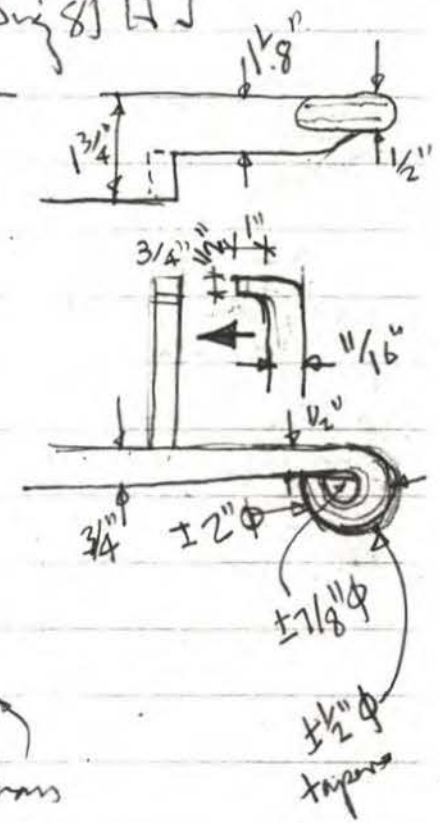
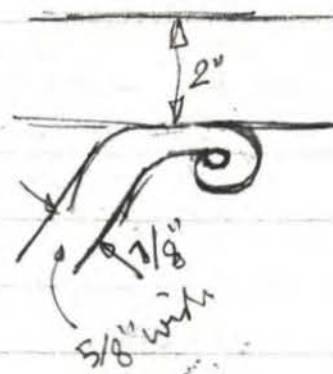
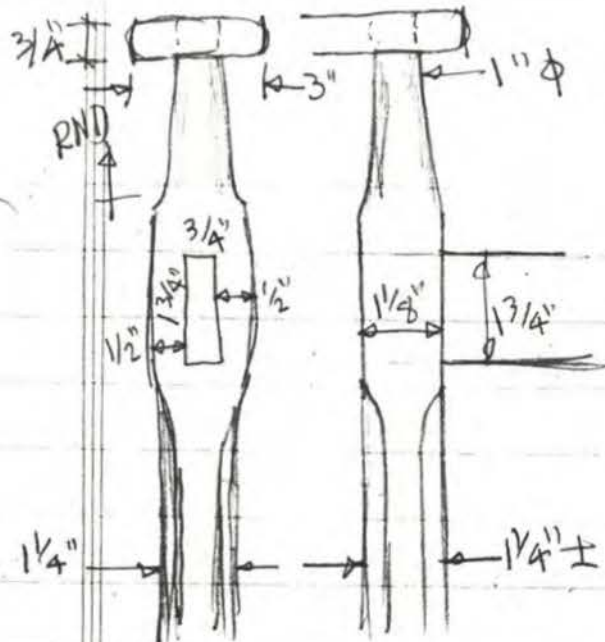

See photos + HKS draws

12/25/35 drawings 1930's

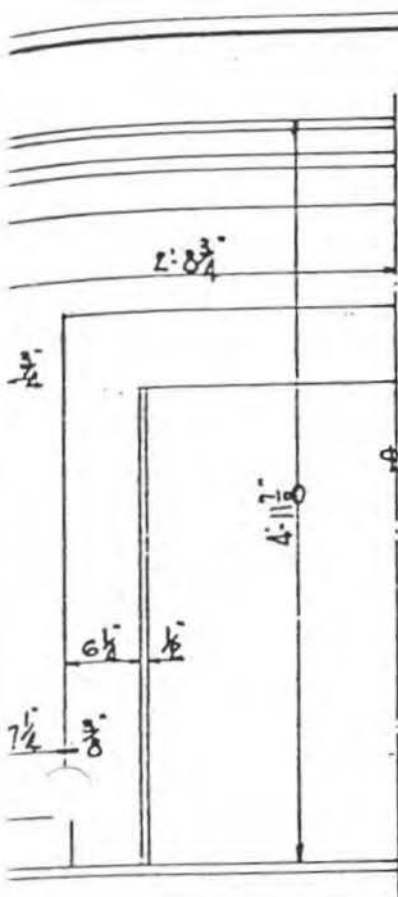

ELEV.

SCALE $\frac{3}{4} = 1'-0"$

LS OF MANTEL
ST & EAST ROOM
T FLOOR

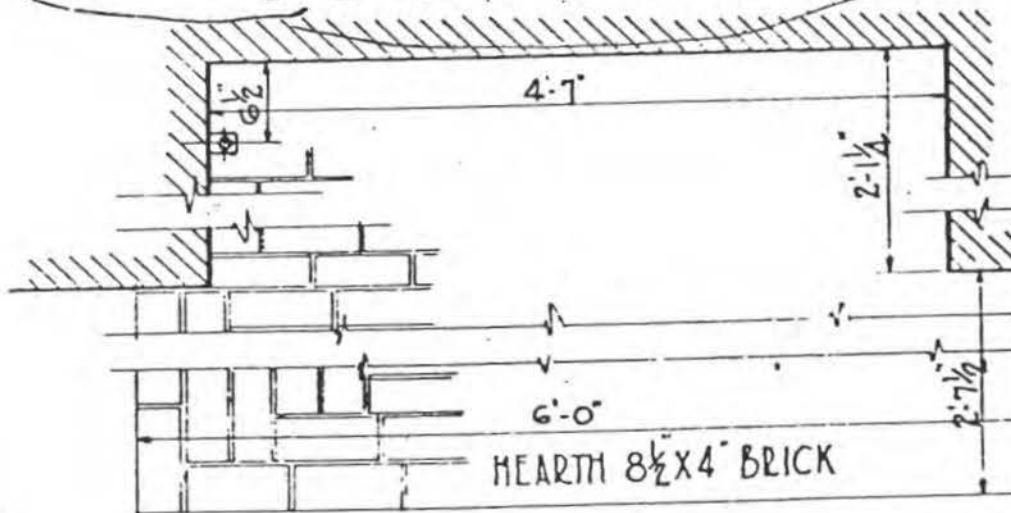
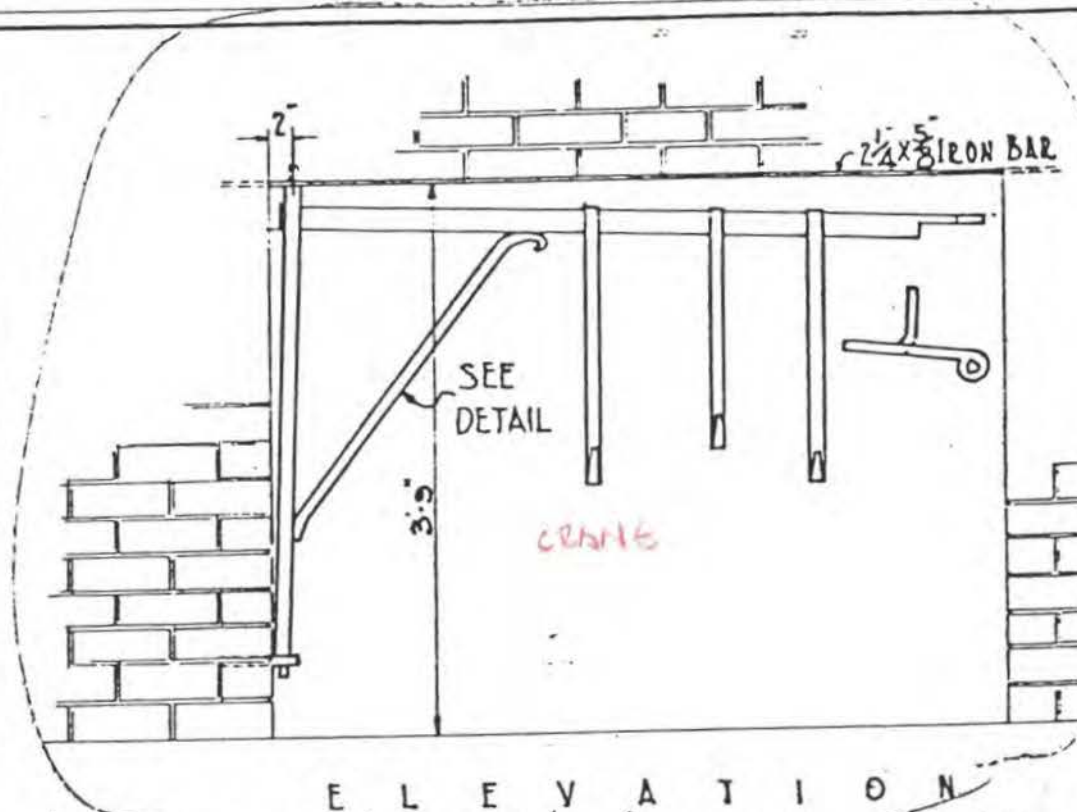

DETAILS OF KITCHEN FIREPLACE

SCALE $\frac{3}{4} = 1'-0"$

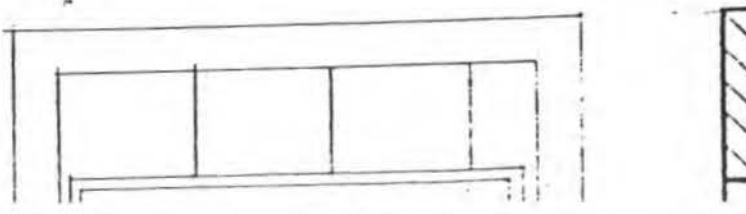
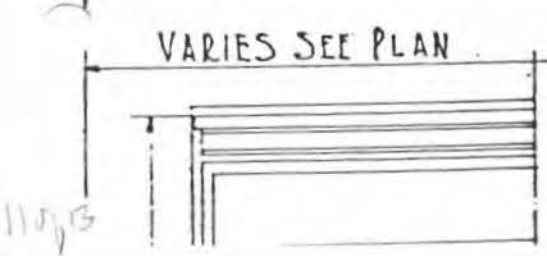

DETAILS OF LATCH ON KITCHEN DOOR

SCALE 3" = 1'-0"

1930 SHABBS
drawing

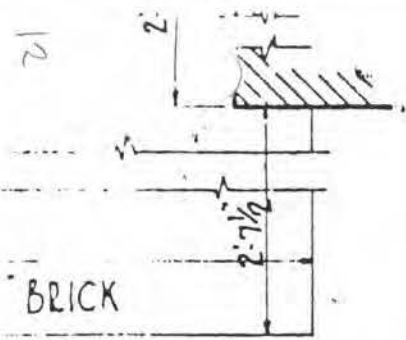

MEN FIREPLACE

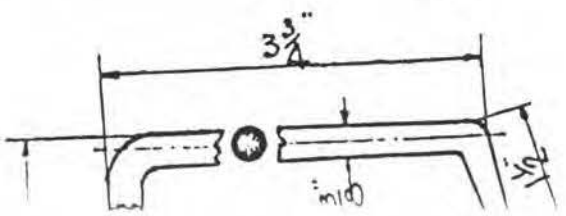
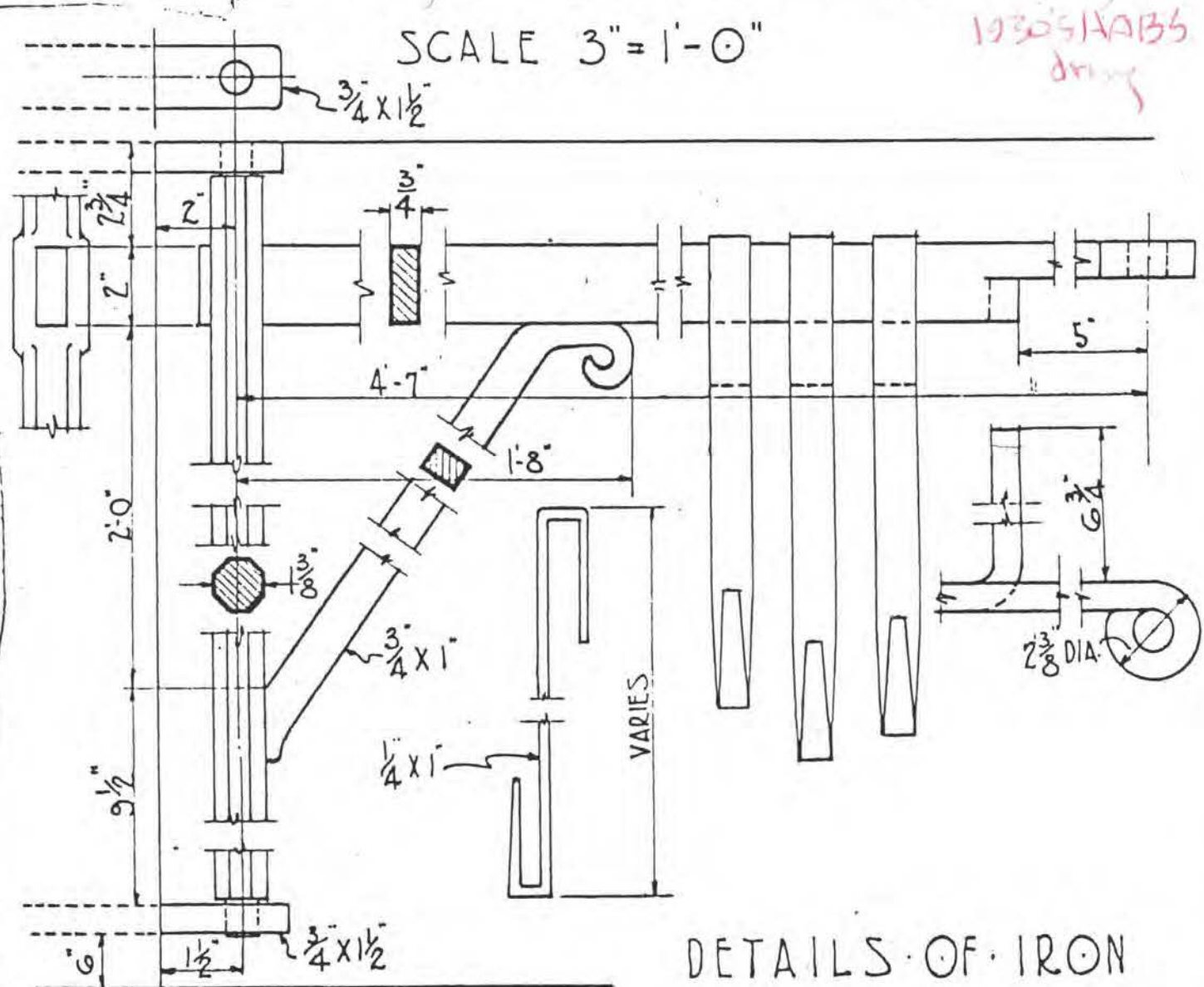
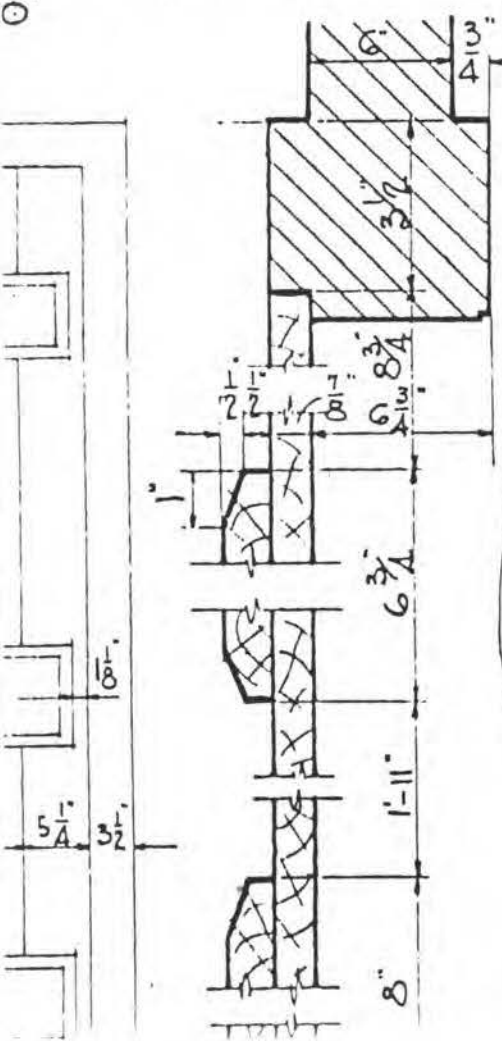

DETAILS OF IRON CRANE IN KITCHEN FIREPLACE

SCALE 3" = 1'-0"

Ca. 1820 Bathm - Mason Use

13
13

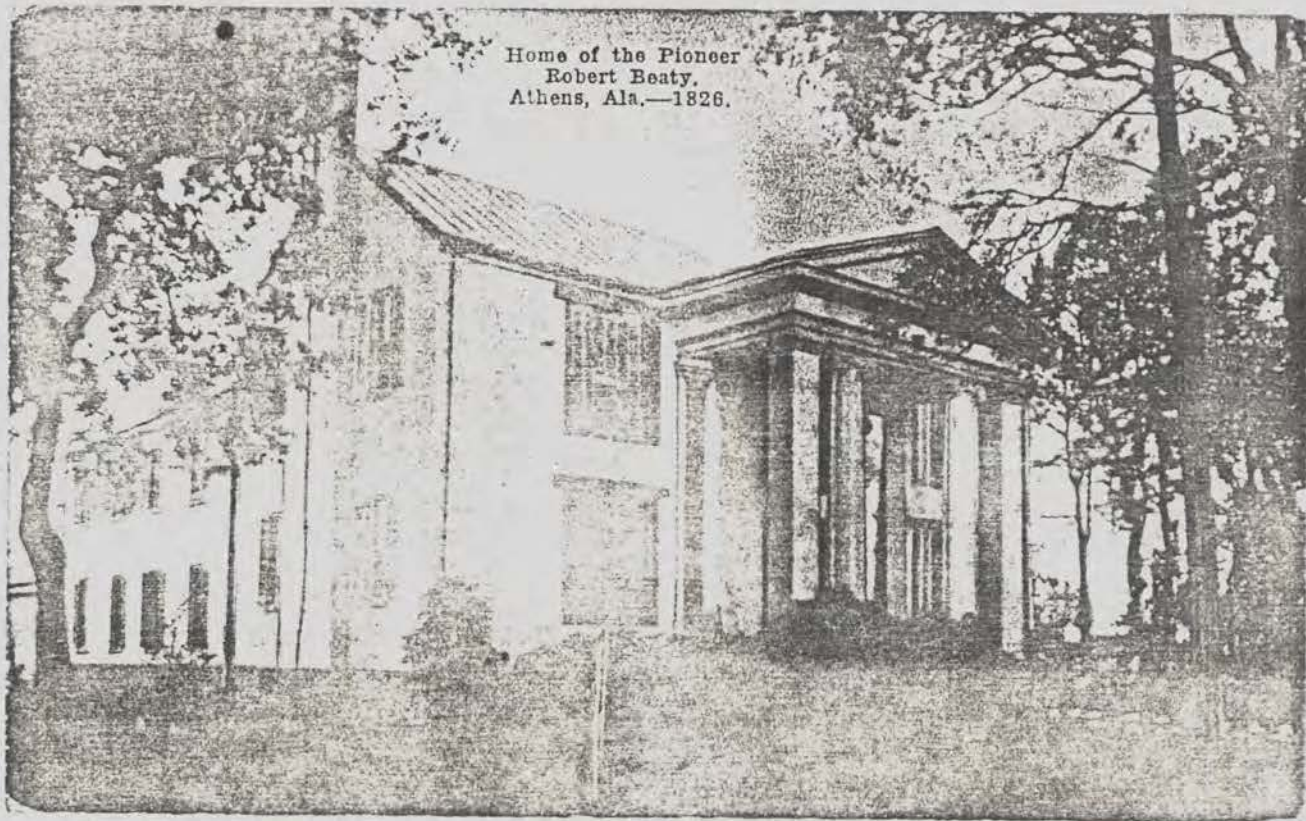

Postcard (enlarged 21%)
No date - probably early to mid 20th cent